



## Quick Start Guide REX 100 WAN|Wi-Fi REX 100 WAN + Wi-Fi

Version

**8** en  
from FW 2.0.6

# Content

1.	Safety instructions 	2
2.	Introduction	3
3.	Preparing the REX 100 unit	3
4.	Access to the myREX24-V2 portal	6
5.	Initial router configuration via the	8
6.	Router configuration transfer options	11
7.	Connection to the machine network	14
8.	Tips and tricks	15
9.	Remote maintenance of Ethernet CPUs	18
10.	Description of LEDs and buttons	19
11.	Restoring the REX 100 router to its default settings	21
12.	Load configuration/firmware update from USBstick	21
13.	Technical data	22

## 1. Safety instructions

### Target audience

This description is only intended for **trained personnel qualified** in control and automation engineering who are familiar with the applicable national standards.

For installation, commissioning, and operation of the components, compliance with the instructions and explanations in this operating manual is essential. The specialist personnel is to ensure that the application or the use of the products described fulfills all safety requirements, including all applicable laws, regulations, provisions, and standards.

### Intended use

The device has a protection rating of IP 20 (open type) and must be installed in an electrical operating room or a control box/cabinet in order to protect it against

environmental influences. To prevent unauthorized operation, the doors of control boxes/cabinets must be closed and possibly locked during operation.

The consequences of improper use may include personal injury to the user or third parties, as well as property damage to the control system, the product, or the environment. The device may only be used as intended. It mustn't be used as sole action of avoidance for dangerous situations for machinery and equipment.

### Operation

Successful and safe operation of the device requires proper transport, storage, setup, assembly, installation, commissioning, operation, and maintenance.

Operate the device only in flawless condition. The permissible operating conditions and performance limits (technical data) must be adhered to.

Retrofits, changes, or modifications to the device are strictly forbidden.

## 2. Introduction

The REX 100 is an industrial router suitable for worldwide remote access to IPv4-enabled devices (PLCs, HMIs, IP cameras, etc.). This Quick Start Guide explains the basic settings in the myREX24 portal and shows how to transfer the configuration made there to the REX 100 unit.

You can find the most current version of the documentation under [www.helmholz.com](http://www.helmholz.com) or scan the QR code directly.



REX 100 WAN | WiFi  
Documentation

## 3. Preparing the REX 100 unit

Depending on the REX variant, the LAN ports P1 to P4 or P2 to P4 are available for connection to the machine network. Internal switch functions are active even if the REX 100 router is not connected to the Internet.

### 3.1 Installation position/minimum clearances

The router was designed to be mounted on DIN rails (as per DIN EN 50 022) and intended for installation in switch cabinets. Installation and mounting must take place in accordance with VDE 0100/IEC 364. The router may only be installed in a vertical installation position.

**Important advance information:** Please use the most current version (V3.7R1.0 or higher) of the "shDIALUP" dial-up software for commissioning. You can download it from [www.helmholz.de](http://www.helmholz.de).

For a successful and secure connection with the myREX24 V2 portal, the firmware statuses of all REX 100 routers should be checked regularly and, when necessary, be updated to the most current status through the system settings of your myREX24 account.

### 3.2 Terminals and Interfaces

Rigid copper wires with a max. diameter of 1.5 mm<sup>2</sup> can be clamped onto the provided connector plug. Network cables corresponding to at least category 5/5e (CAT-5) should be connected to the RJ-45 sockets.

Minimum distances from neighboring modules:

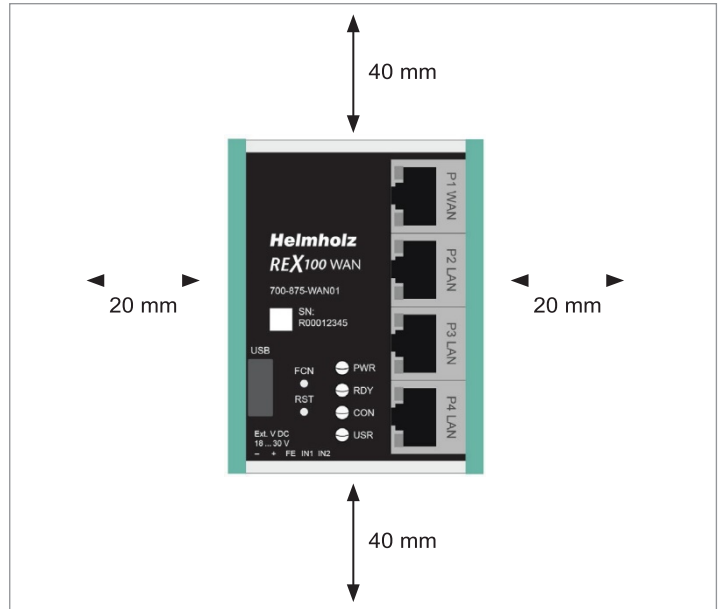

### 3.3 power supply

The REX 100 must be supplied with 24 V DC at the 18 ... 30 V DC wide-range input via the supplied connector.

*Note: Please make sure to connect the functional earthing connection (FE) of the device to the earthing of your control cabinet or system structure to ensure correct ESD derivation of the network sockets.*

### 3.4 Digital inputs/outputs IO1 and IO2

The bidirectional connections IO 1 and IO2 can - independently of one another – be configured as digital inputs (standard setting) or as digital outputs.

#### 3.4.1 Inputs

The alarm inputs can be activated with potential-free switches, buttons or relay contacts. IN1 can, for example, be used for the VPN establishing of connection with the myREX24 portal. An alarm can be triggered with the IN2.

#### 3.4.2 Outputs

When selecting for the output circuit, the REX can provide the status of an active Internet, VPN or user portal connection as a signal. Each output can have a max. 0.5A (@ 24 V).

The parameterization is carried out via the alarm management in the myREX24 V2 portal. Alternatively, the input and output functions could also be displayed in a dashboard using the data point functions.

*Note: When using outputs O1 and O2, the corresponding input signals I1 and I2 assume the respective output status and can themselves no longer be used externally for other alarm input signals.*

### 3.5 Antenna connection

Connect one of the 2.4 GHz WLAN antennas, available in the Helmholtz accessories, to the RP-SMA socket and mount them in such a way that a permanent radio connection to a Wi-Fi access point is possible.

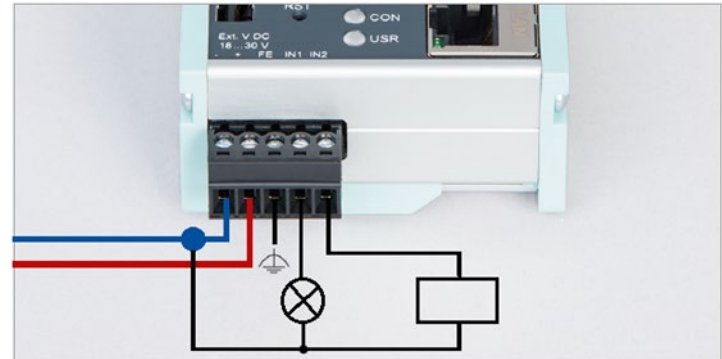
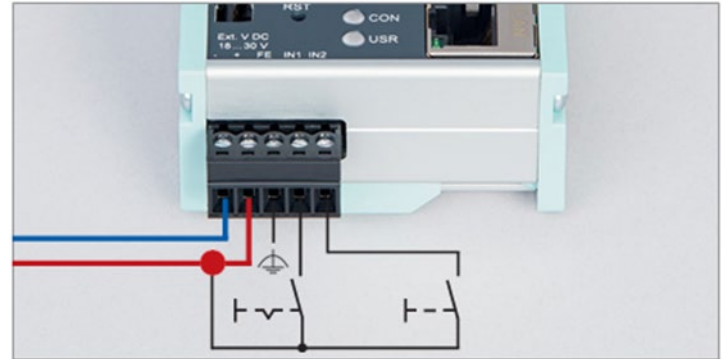

### 3.6 Boot process

The PWR LED lights up when the 24-volt supply voltage is applied. The boot process starts following the internal system check, which is indicated by the blinking RDY LED. The REX 100 is ready for operation as soon as the PWR LED and RDY LED light up continuously. (duration: approx. 90 sec.)

### 3.7 REX 100 WAN

Connect the WAN interface of the REX 100 (P1 WAN) with a patch cable with the higher level (company) network/router. 3 LAN ports are available for connection to the machine network and for commissioning via PC.

### 3.8 REX 100 Wi-Fi

After connecting a WLAN antenna (2.4 GHz), a stable Wi-Fi radio connection to the higher-level (company) network / router must be ensured. Here are 4 LAN ports available for connection to the machine network and for commissioning via PC.

### 3.9 REX 100 Wi-Fi + WAN

With this device variant, a failover can be parameterized in the configuration if necessary (see chapter 5.3.2). For this application, the requirements from points 3.7 and 3.8 must be met. The VPN connection is primarily implemented via the WAN interface. If the connection is not established or is interrupted, the REX automatically switches to the Wi-Fi connection. As soon as WAN is available again, it switches back.

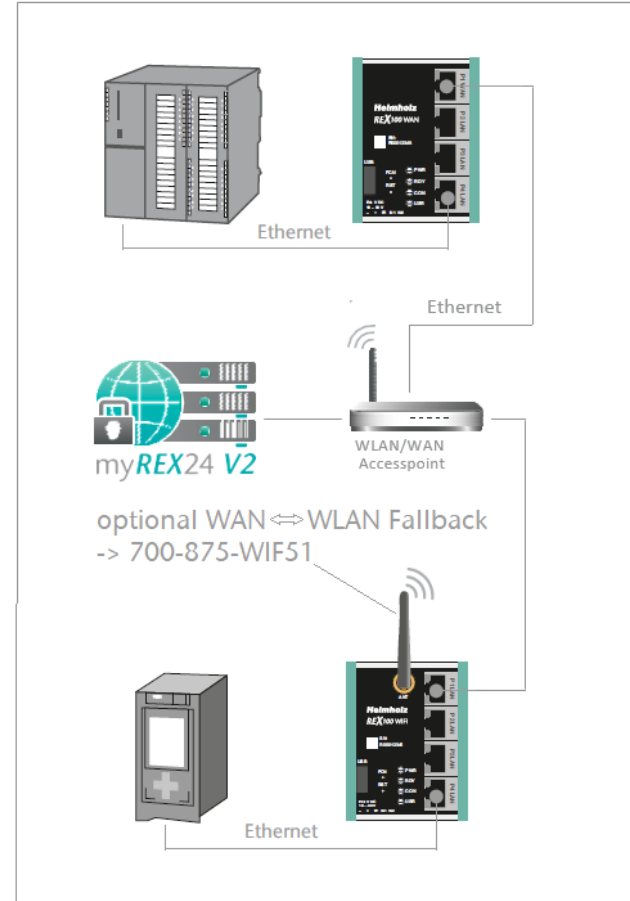

## 4. Access to the myREX24-V2 portal

The complete configuration of the REX 100 takes place via the myREX24 V2 portal. A secure connection to the portal is required for this: The shDIALUP remote client software enables you to administrate the myREX24 V2 portal and realize a VPN tunnel to a REX router. The software (shDIALUP) can be found in the download area at [www.helmholz.de](http://www.helmholz.de). There you can also download more documents with additional information at any time. Alternatively, you can create the REX configuration with an HTTPS-secured direct call from your browser. The call is possible via the following URL: <https://v2.myREX24.net>. However, it is not possible to realize a VPN remote maintenance via the browser. Always use your myREX24 V2 account data to log in.

### 4.1 Registration

You should only register at [www.myREX24.net](http://www.myREX24.net) if you don't yet have a myREX24 V2 portal account or have not received user access from a myREX24 account administrator. Fill out the required fields there. After your data is checked by our service team (Mon. to Fri., 8 a.m. to 5 p.m. CET), you will receive two separate e-mails with the access data. One e-mail contains the username, and the second the password.

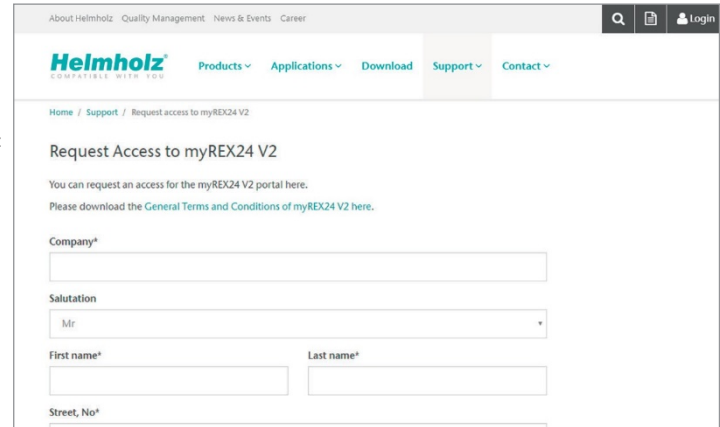

The screenshot shows the Helmholz website's 'Request Access to myREX24 V2' page. The page has a navigation bar with 'About Helmholz', 'Quality Management', 'News & Events', and 'Career'. Below the navigation bar is the Helmholz logo and a menu with 'Products', 'Applications', 'Download', 'Support', and 'Contact'. The main content area is titled 'Request Access to myREX24 V2' and contains a form with the following fields: 'Company\*', 'Salutation' (with a dropdown menu showing 'Mr'), 'First name\*', 'Last name\*', and 'Street, No\*'. There is also a link to download the 'General Terms and Conditions of myREX24 V2 here'.

### 4.2 Logging in to the myREX24 V2 portal server

Install the shDIALUP software with administrative rights under a Windows<sup>2</sup> operating system. After opening the program, select the "v2.myREX24.net" server in the top menu bar and then log in to the myREX24 V2 portal with your access data.

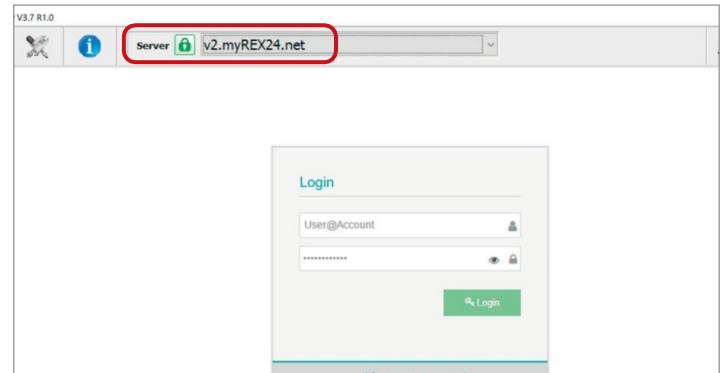

The screenshot shows the myREX24 V2 portal login interface. At the top, there is a server selection dropdown menu with 'Server' and 'v2.myREX24.net' selected. Below the dropdown is a 'Login' form with two input fields: 'User@Account' and a password field with a visibility toggle. A green 'Login' button is located at the bottom right of the form. The version number 'V3.7 R1.0' is visible in the top left corner.

#### Notes:

*Your login name can be comprised of your username and company name separated by the @ symbol, for example: [admin@helmholz](mailto:admin@helmholz.de). Following the initial login, you will be prompted to register a new, individual password for your account. As the account administrator, you can create and administer additional users after logging in to the myREX24 V2 portal if necessary.*

### 4.3 Navigation in the portal

Once a user has logged in for the first time, he or she is guided through a tutorial. Navigation, basic settings and switching from the simple view to the extended view are shown.

### 4.4 Simple and extended views

You can choose between the two views in the menu interface of the myREX24 V2 portal.

The “simple view” is active the first time you log in. You can switch to the “extended view” at any time without changes being lost or losing their validity.

The simple view is mainly used throughout the rest of this Quick Start Guide. The extended view is also presented in some places for purposes of illustration.

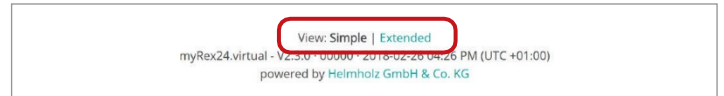

#### Simple view

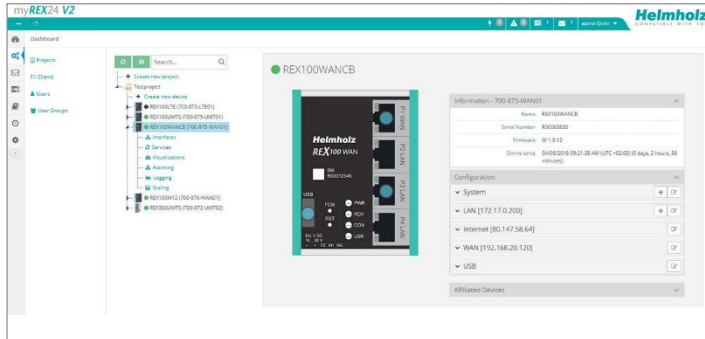

#### Expanded view

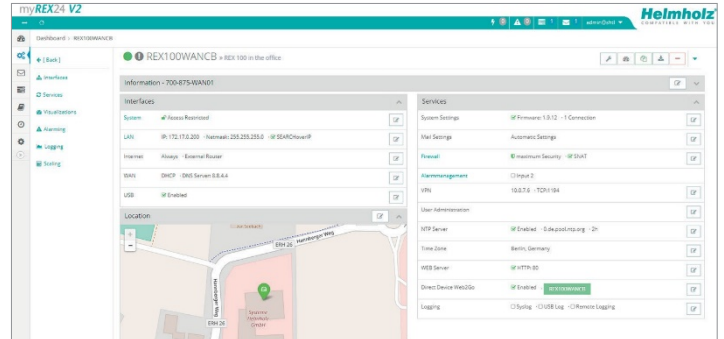

## 5. Initial router configuration via the myREX24 V2 portal

The following information describes the basic configuration steps required in order to set up a REX router for a VPN connection. A description of the extended functions can be found in the online help or in the manuals/white papers. You can go to the online help in the myREX24 V2 portal using the question mark symbol in the lower left-hand area of the screen. When you log in for the first time, the myREX24 portal guides you through a brief tutorial. Please change the password for your myREX24 account following the tutorial.

### 5.1 Creating a new project

A project is the highest level for carrying out the following tasks:

- Device administration
- Remote maintenance
- Monitoring and alarms
- Data logging
- Visualizations

Initially, at least one new project must be created in which a router is assigned. Navigate to the Administration section using the following symbol  (the tutorial also brings you to this point).

A unique project name is now issued in this menu.

Additional account users, if created, can be assigned to this project on the "Access" tab.

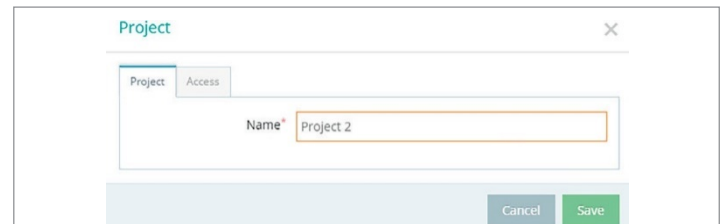
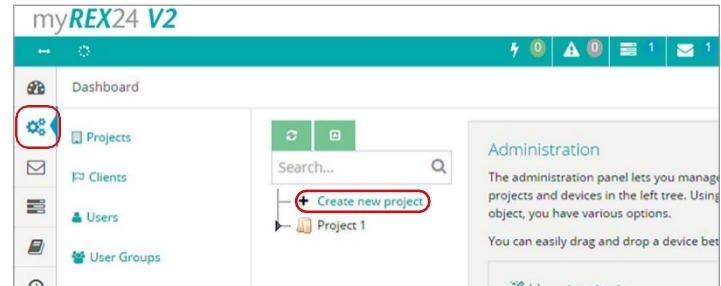
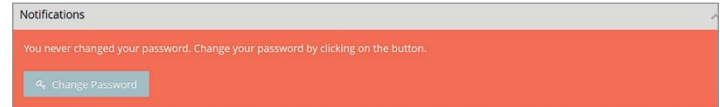



## 5.2 Creating a new device

A router can be added to the tree structure using the plus symbol **+** or with a right-click of the mouse. If a project does not yet have a router, the same function is made available in the main view by way of the green button “Create new device”. Clicking the respective button starts the configuration assistant, which guides the user through the settings.

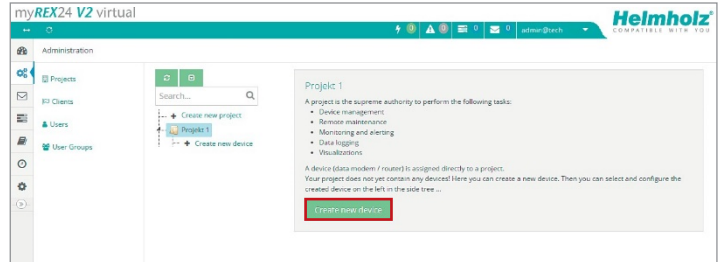
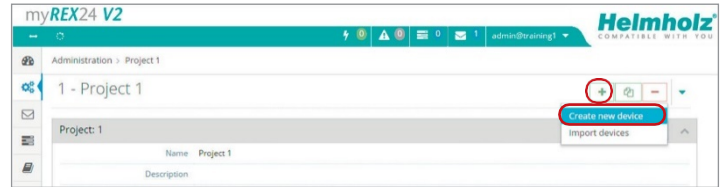

## 5.3 Configure REX 100 (connection data)

Three simple steps are enough for minimal configuration of the router.

- Selection of the device type
- Network settings
- Transfer of the configuration to the REX router

### 5.4 Step 1 “Device” – Selection of the type and name

In the first step, the correct device type (matching the device order number) must be selected. A unique, freely selectable name should be assigned to this router. Only numbers and letters may be used (0 to 9, A to Z, a to z and no spaces or special characters).



## 5.5 Step 2 “Internet” – Network settings

In Step 2, the network configuration for the LAN and mobile WAN side of the device is defined.

- **LAN** All REX 100 routers come with the IP address 192.168.0.100/24 as a default. If necessary, modify the IP address and subnet mask according to the specifications from the machine network to be maintained remotely.
- **WAN** The required information for the DHCP or static IP settings is provided by the respective network administrator. DHCP is preset at the factory.
- **Wi-Fi** Enter the Wi-Fi-specific access data (only 700-875-WiFi1). The corresponding data provides you with the responsible network administrator.

*Note: If you use DHCP, make sure that the DHCP server does not assign an IP address the WAN interface that is already active on the LAN side. IP addresses from two different subnets must be assigned to each router’s LAN and WAN interfaces.*

## 5.6 Step 3 “Configuration” – Coupling/pairing the router with the portal

The basic parameters of the minimum configuration of the REX 100 are now stored in the portal account and must now be transferred to the device (see chapter 6).

*Note: We recommend the “Download configuration to PC” variant for the initial configuration.*

The screenshot displays the configuration interface for the REX 100 router, specifically Step 2: Internet. At the top, a progress bar indicates three steps: 1. Device (completed, marked with a green checkmark), 2. Internet (current step), and 3. Configuration. The interface is divided into several sections:

- LAN:** IP address: 192.168.0.100; Netmask: 255.255.255.0
- Internet:** Internetconnection: WiFi (dropdown menu)
- WiFi Access:** SSID: (empty field); Authentication Mode: SHARED (dropdown menu); Encryption Mode: None (dropdown menu); Encryption Key: (masked field with eye icon); Encryption Key confirmation: (masked field with eye icon)
- WiFi Settings:** Channel: Auto (dropdown menu); WiFi Type: DHCP (dropdown menu)

At the bottom of the interface, there are three buttons: a red "Cancel" button, a grey "Prev" button, and a green "Next" button.

## 6. Router configuration transfer options

Newly created or subsequently modified device configurations can be transferred to the REX 100 in a variety of ways.

### - 1. Download configuration to PC (via USB flash drive)

The configuration file is saved on the PC and can subsequently be transferred to the REX 100 using a USB stick (subsequent procedure described in chapter 5.1).

### - 2. Synchronize (recommended for subsequent modifications)

If the router has already been configured and a connection with the portal is established, each subsequent change to the configuration can be carried out via the existing VPN remote connection (further procedure described in Section 5.2).

### - 3. Transfer configuration to the device (with LAN connection, only possible via shDIALUP)

For this configuration option, the REX 100 must be accessible directly in the LAN from the PC. The PC must also be logged in on the Internet via the shDIALUP dial-up client using your myREX24 account at the same time.

The transfer via USB stick (point 1) is explained in this Quick Start Guide, and how retroactive changes can be transferred via the function "Synchronization" (Point 2).

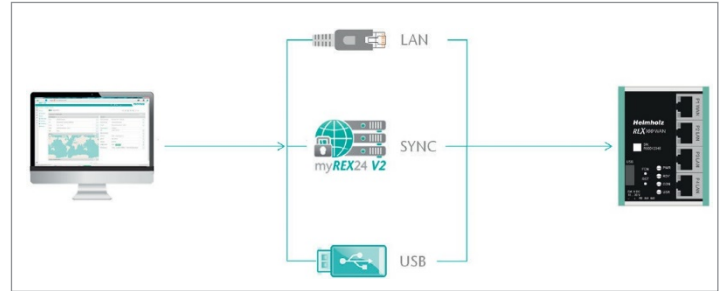

## 6.1 Transferring the configuration using a USB flash drive

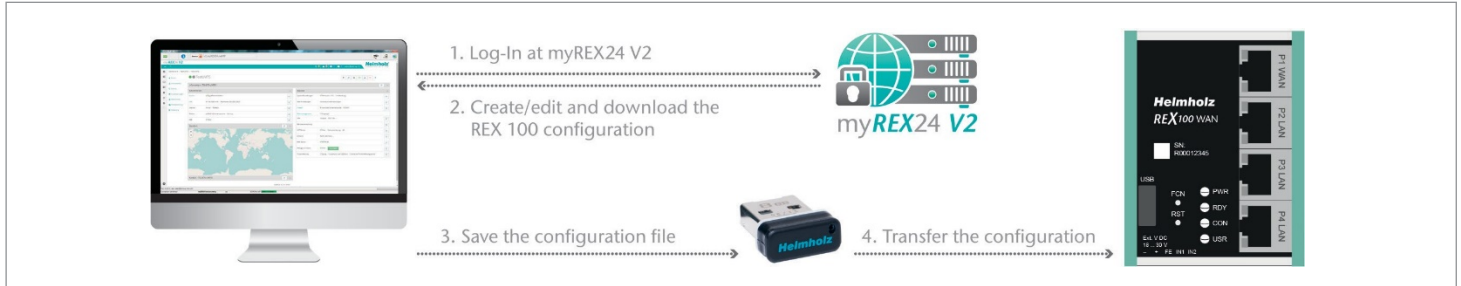

Ensure that the power supply is connected to the REX 100. Download the configuration file provided through the myREX24 portal to the FAT-formatted USB flash drive connected to your PC using the download symbol.

*Note: The myrex24.mbn(x) configuration file must be stored in the root directory of your USB flash drive and may not be renamed.*

The screenshot shows a progress bar with three steps: Device, Internet, and Configuration. The Configuration step is the active one, indicated by a circled '3'. Below the progress bar, there is a 'Download' section with a large green download icon. The text below the icon reads:



Download the device configuration file by clicking on the download icon above.  
Once downloaded, put it on a USB drive and plug it into your device.  
As soon as the LED Usr starts blinking, press the Function button until the Usr LED is constantly on.

A 'Finish' button is visible in the bottom right corner of the interface.

Now carry out the steps described on page 21 in chapter 11 “Load configuration/firmware update from the USBstick”.

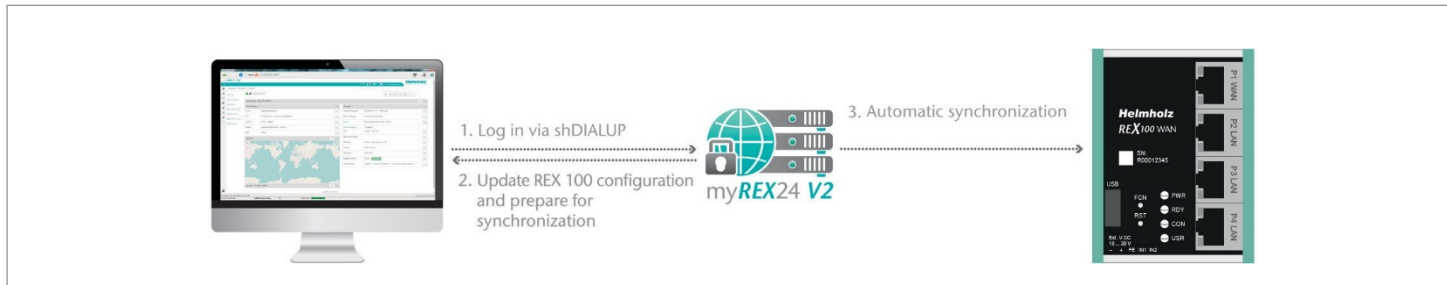
## 6.2 Synchronization



As soon as the REX 100 has logged into your account in the portal, you can transfer subsequent changes at any time with “Synchronize”. Where there is an existing myREX24-V2 portal connection, the REX 100 checks cyclically whether there is a new configuration available for its serial number and then loads it automatically. As soon as you have modified and saved one or more parameters, the following symbol appears next to the Online LED:  “Device configuration is not up to date”. Click this  symbol (or the “Synchronize” button), to start the process.

### Synchronization in the simplified view

myREX24 V2

Administration

Projects

Users

User Groups

Project 1

- Create new project
- REX100L7E (700-875-L7E01)
- REX100M0N1 (700-875-M0N101)
- REX100WANCB (700-875-WAN01)

REX100WANCB

Your device configuration differs from the portal configuration. Please **Synchronize** your device to online and connected to the portal, you can establish an active connection to the device.

**Synchronize**

Connect to REX100WANCB

Information - 700-875-WAN01

Name	REX100WANCB
Serial Number	830003030
Firmware	IP 1.9.12
Online since	04/06/2018 01:02:27 PM (UTC+02:00) (9 days, 21 hours, 46 minutes)

Configuration

System

### Synchronization in the extended view

myREX24 V2

Dashboard - REX100WANCB

REX100WANCB - REX 100 in the office

Information - 700-875-WAN01

Interfaces

System	<input checked="" type="checkbox"/> Access Restricted
LAN	IP: 192.178.200 - Netmask: 255.255.255.0 - IP: 88888888
Internet	Always - External Router
WAN	Dhcp - DNS Server: 8.8.4.4
USB	<input checked="" type="checkbox"/> Enabled

Location

Services

System Settings	<input checked="" type="checkbox"/> Firmware: 1.9.12 - 1 GB
Mail Settings	<input checked="" type="checkbox"/> Automatic Settings
Firewall	<input checked="" type="checkbox"/> Maximum Security - <input checked="" type="checkbox"/> SNAK?
Alarmmanagement	<input type="checkbox"/> Input 2
VPN	<input type="checkbox"/> 10.0.0.0 - TCP:1984
User Administration	
NTP Server	<input checked="" type="checkbox"/> Enabled - <input type="checkbox"/> Disable synchronization - 2h
Time Zone	Berlin, Germany
WEB Server	<input checked="" type="checkbox"/> HTTP:80
Direct Device Web2Go	<input checked="" type="checkbox"/> Enabled - <b>Synchronize</b>
Logging	<input type="checkbox"/> Syslog - <input type="checkbox"/> USB Log - <input type="checkbox"/> Remote Logging

The synchronization function is confirmed through the following dialog.

In this menu, you can select optional user-defined settings, such as the sending of information/confirmation mails.

The REX router now accepts the new settings and restarts automatically. As soon as the boot process has concluded, the REX router logs into the portal again.

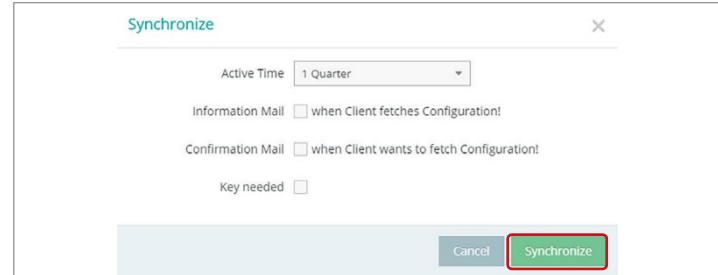

## 7. Connection to the machine network

*Note: The following steps presume that the REX 100 has already been configured and that you have successfully logged into your account with shDIALUP.*

*A secure VPN connection to the end device cannot be implemented via the browser view (<https://v2.myREX24.net>).*

Logged-in REX 100 routers are identified with a green circle in the dashboard. The secure VPN connection between the PC and REX router is not established until the connection button is clicked.

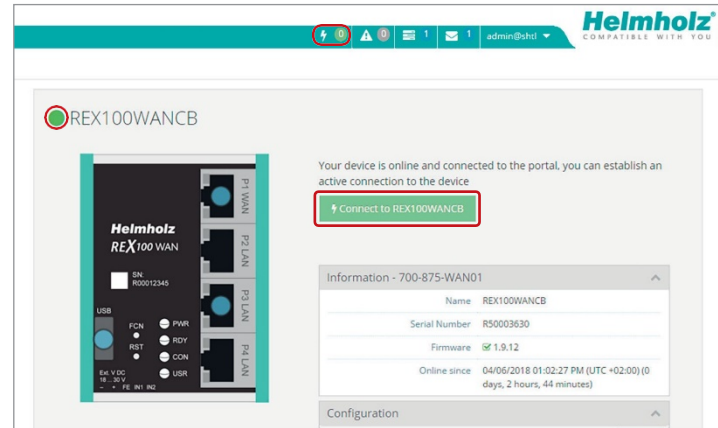

Effective immediately, you can view the setup of your REX router and the functional overview of the myREX24 V2 portal very easily online.



<https://youtu.be/8a1Xnu9IJ4g>  
Video tutorial (3:22 min.)

The active connection status to the REX 100 is represented by an animated orange connection button. The number of active connections made using this account is shown with details in the menu bar.

Once the VPN connection to the REX 100 has been established, all the IPv4 packets valid for the applicable LAN network on the system side will be forwarded. The parameters (port, VPN IP, LAN IP etc.) used for this connection are also shown with details in the status bar at the bottom.

To end a remote access connection, click the orange animated connection button and then confirm disconnection of the remote connection.

## 8. Tips and tricks

### 8.1 Checking the device status

The device status website of the REX 100 shows the connection status and the active configuration data of the router. To this purpose, the REX 100 must be accessible in the LAN, meaning that the TCP/IP address of a PC must be in the same IP subnet. To this purpose, enter the LAN IP address of the REX 100 into the address bar of a browser.

Authenticate yourself with the standard

- **user:** helmholz and the
- **password:** router

To view more information on each step of the connection, click on the Info icon  in the status fields.

*Note: If the website of the REX 100 is not accessible, please check the corresponding setting in the myREX24 portal. Make sure that there are no address space conflicts with any other network interfaces (do not assign the same IP address more than once) in order to be able to communicate with the REX 100.*

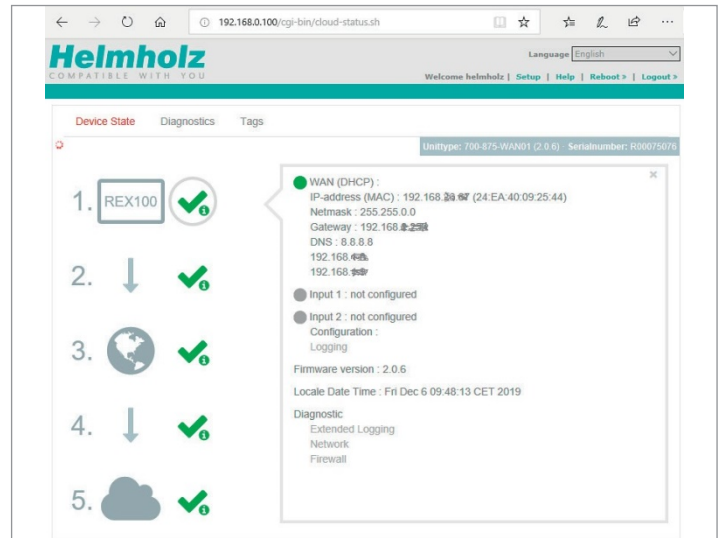
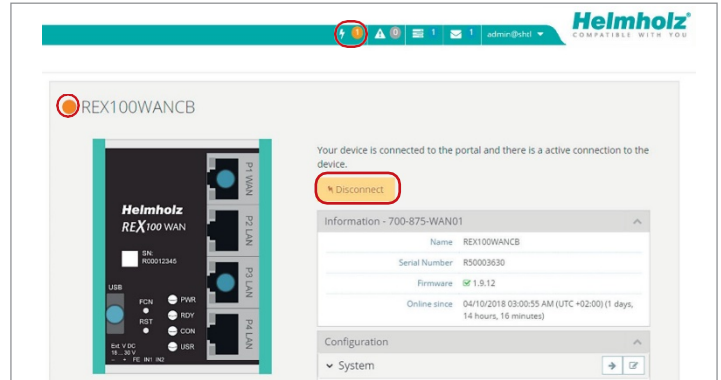

## 8.2 VPN port and China gateway

The REX 100 establishes an outbound TCP connection with the address VPN-V2. myrex24.net (5.39.123.21).

To be able to establish a secure connection to the myREX24 V2 server with shDIALUP or the REX 100, at least one of the following TCP ports (80, 1194, or 443) must be enabled for the VPN tunnel in the customer firewall.

This communication takes place via port 1194 by default, which is also preset.

Please clarify all details of the settings in advance with the responsible IT department on site. If necessary, the port in the REX 100 can be changed in the VPN settings.

Gateway: By default, no gateway is set!

If the REX Router is used in China, the Gateway “China –Shenzhen Datacenter” can be selected.

URL: vpncn-v2.myrex24.net

IPv4 address: 43.247.70.163 (if name resolution does not work).

*Note: Do not use the China Gateway outside China!*

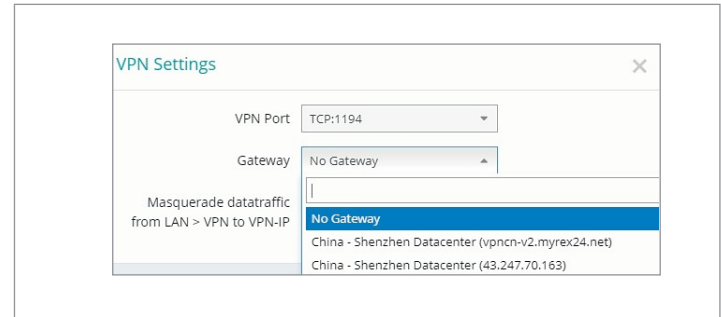
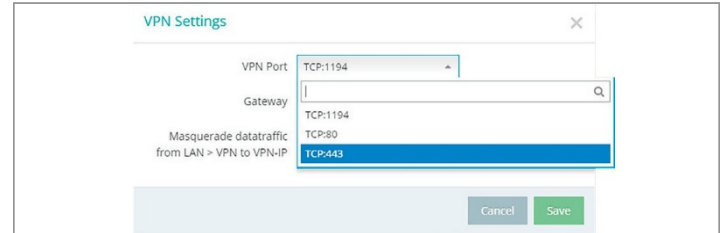

## 8.3 Diagnostics page

In the event of irregularities or interruptions when establishing the connection, the diagnostics page can provide troubleshooting assistance. In the event of an error, Helmholtz technical support requires the respective result from the individual and autonomous test functions.

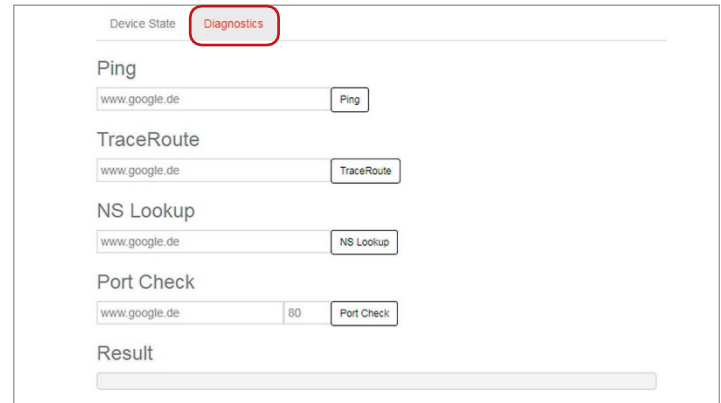



#### 8.4 Is a MAC address filter activated in the firewall?

It may be necessary to approve the MAC address of the REX 100 in the higher level DSL modem or the firewall. Should it not be possible to establish a connection, please ask the responsible network administrator whether such a MAC address filter has been activated.

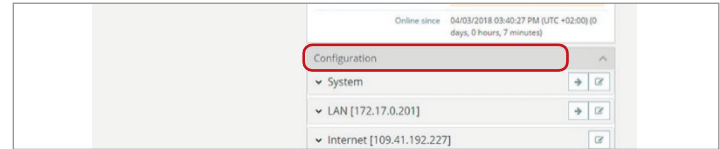

#### 8.5 Is the connection established over a proxy?

If a connection is not established on the customer network, the required proxy settings may not have been stored or may be faulty. These settings may be adjusted on the configuration page of the REX 100 in the Internet settings.

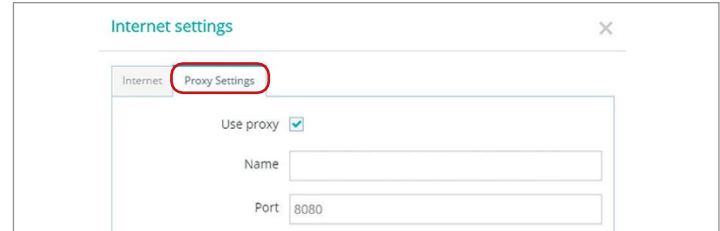

#### 8.6 Device configuration: Services – NTP server

For the internal system time of the REX 100, this carries out a comparison using a time server on the Internet at regular intervals. Where necessary, you can individually set the preset NTP server entry and the interval.

*Note: Various functions in the myREX24 portal require a current time setting in the REX 100.*

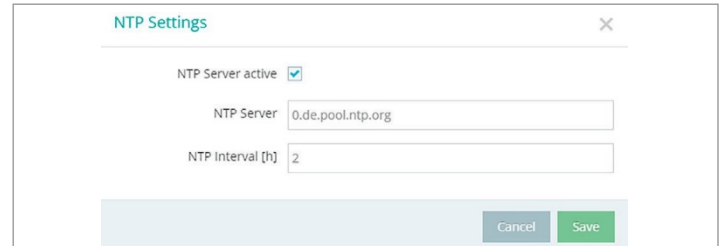

#### 8.7 Device configuration: Services – Mailsettings

If you would like to use the REX 100 function for the automatic sending of e-mails, port 25 (SMTP) may not be blocked in the firewall of the customer network. You can also use alternative e-mail servers to send e-mails.

## 9. Remote maintenance of Ethernet CPUs

Notes:

*The LAN ports are suitable for 100 Mbps and full duplex operation and support auto-crossover and auto-negotiation. No special PROFINET functions are supported.*

*When connecting additional Ethernet participants (PLC/panel) on the REX 100, it must be ensured that the IP addresses of the devices lie within the address range of the LAN interface of the REX 100.*

### 8.8 Device settings: Services – Firewall – SNAT

With a REX 100, the SNAT function is activated as a default. With this setting, participants for which no gateway\*/router has been entered are accessed via the VPN tunnel. For the CPUs and panels of some manufacturers, it can be the case that you need to explicitly enter the gateway\* and deactivate the SNAT function in order that a remote connection with the end device is possible.

\*Gateway: This refers to the configured LAN IP address of the REX 100.

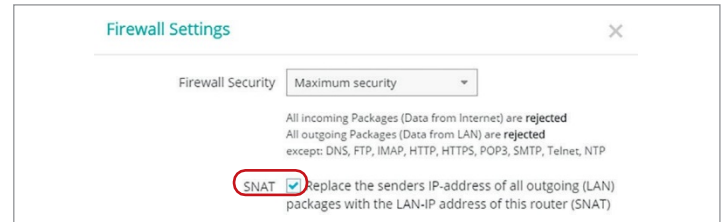

To access a PLC or panel via the VPN tunnel, the OpenVPN adapter must be selected in the corresponding engineering tool as the interface. The virtual network connection responsible for this is the TAP Windows<sup>2</sup> Adapter V9.

The setting to be selected in the PG/PC interface module from the SIMATIC STEP 7<sup>1</sup> software is emphasized in the detail to the right.

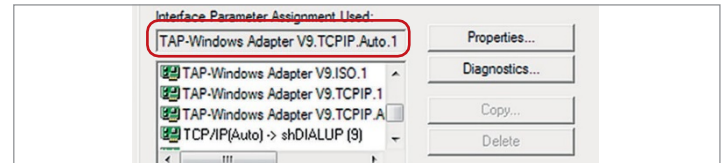

## 10. Description of LEDs and buttons

### 10.1 Function and status LEDs in normal operation

PWR	Indicator light for the power supply
RDY	Readiness indicator (this LED must show a solid light after a max. of 110 sec.)
CON	<p><b>Off:</b> There is no active Internet or VPN connection</p> <p><b>Solid light:</b> Internet connection active or possible, but VPN connection inactive</p> <p><b>Flashing (1.5 Hz):</b> VPN connection is active</p> <p><b>Rapid flashing (3 Hz):</b> The router is attempting to establish a VPN connection</p>
USR	<p><b>Solid light:</b> When loading default settings, firmware files, or device configurations</p> <p><b>Flashing (1.5 Hz):</b> A portal configuration was recognized on the USB stick (see FCN button)</p> <p><b>Rapid flashing (3 Hz):</b> A firmware file was recognized on the USB stick (see FCN button)</p>

LED	LED color	LED status	Description
WAN & LAN	Orange	LED on	Network connection present
	Green	LED flashing	Network data traffic active

### 10.2 Buttons

FCN	<ol style="list-style-type: none"> <li>Function key for manually establishing the connection with the portal server</li> <li>If the USR LED starts flashing, this means that you have ten seconds to press this button in order to load data from an inserted USB stick.</li> </ol>
RST	Reset button for restarting the router

Note:

*Use the provided tool to activate the buttons (SIM card ejector).*

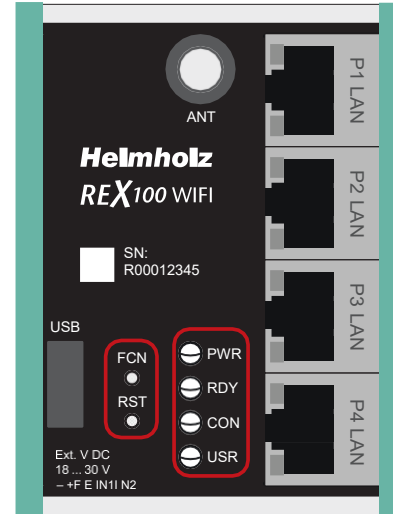

### 10.3 myREX24 V2 portal LEDs

●	The device is not connected with the portal.
●	The device has logged in at the portal and is thus online.
●	Depending upon the device type, the device is connected with <ul style="list-style-type: none"><li>- a machine connected with the device (PLC)</li><li>- the website of a connected machine</li><li>- the integrated web server of the device (router)</li></ul>
!	The device configuration is not up to date. This means: <ul style="list-style-type: none"><li>- the configuration of a newly created device has not yet been transferred to the device</li><li>- or the changed configuration of an existing device has not yet been transferred to the device/no synchronization has been carried out.</li></ul> This symbol can be displayed in connection with any of the symbols named above.

The screenshot displays the myREX24 V2 portal interface for a device named REX100WANCB. On the left, there is a physical device image with a teal border. The device is labeled 'Helmholz REX100 WAN' and has a serial number 'SN: RD0012345'. It features a USB port, a power button (PWR), and several indicator lights (FCN, RST, RDY, CON, USR). On the right side of the interface, there is a 'Configuration' section with a tree view showing 'System', 'LAN [172.17.0.200]', 'Internet [80.147.58.64]', 'WAN [192.168.20.120]', and 'USB'. Below this, there is an 'Information' section for '700-875-WAN01' with details: Name: REX100WANCB, Serial Number: R50003630, Firmware: 1.9.12, and Online since: 04/06/2018 03:49:34 PM (LT minutes). At the bottom, there is an 'Affiliated Devices' section.

Information points ● for detailed information about the status of the interface

## 11. Restoring the REX 100 router to its default settings

In order to reset the REX 100 to the factory settings, the following steps are necessary:

- Apply a supply voltage (or press "RST") until the PWR LED lights up.
- Wait until the RDY LED flashes.
- Press the FCN button for approx. 10–15 seconds until the USR LED flashes orange.
- After you release the FCN button, the REX 100 reboots and once again has the factory settings.

## 12. Load configuration/firmware update from USB stick

To provide the REX 100 with a configuration or perform a firmware update from a USB stick, please carry out the following steps:

- The start process of the device must be completed (PWR & RDY LEDs light up continuously).
- Save the file in the root directory of a standard FAT-formatted USB stick. Important! Do not change the file name.
- Insert the USB stick into the USB interface of the REX 100.
- Once the USR LED starts flashing, you will have ten seconds to press the FCN button. Then hold it pressed until the USR LED lights steadily.
- During the operation, the voltage supply should not be interrupted.
- Once the USR LED lights up continuously, you can release the FCN button, at which point the data will be loaded from the USB stick.
- The process is complete once the PWR and RDY LEDs light up again permanently.

*Important: The IP address of the REX 100 LAN interface is reset to 192.168.0.100/24.*

The firmware and the dial-up software „shDIALUP“ of the REX 100 can be easily updated via the website.

Please download the desired file from [www.helmholz.com](http://www.helmholz.com) or scan the QR code.



**REX 100 WAN | WiFi**  
Firmware/„shDIALUP“

*Note: Ensure that either only the firmware file or only the configuration file is found in the root directory of the USB stick. If you wish to update both the firmware and the configuration, carry out the following steps consecutively for each file.*

*Note: Once the configuration file has been successfully transferred, the file will automatically be renamed "Xmyrex24.mbn(x)", making it impossible to accidentally reuse it a second time.*

## 13. Technical data

### REX 100 WAN (700-875-WAN01)

Dimensions (DxWxH)	32,5 x 58,5 x 76,5 mm
Weight	Approx. 130 g
Number of inputs   type	2   DC 24 V, as per DIN EN 61131-2 Type 2
Number of outputs   type	2   DIN EN 61131-2 Type 3
WAN interface	1 x
- Type	10 Base-T/100 Base-T
- Connection	RJ45 socket
- Transmission rate	10/100 Mbps
LAN interface	3 x
- Type	10 Base-T/100 Base-T
- Connection	RJ45 socket
- Transmission rate	10/100 Mbps
USB interface	1 x
- Protocol	USB 2.0 host
- Connection	USB A socket
Status indicator	4 LEDs, function status 8 LEDs, Ethernet status
Voltage supply	DC 24 V, 18 ... 30 V DC
Current draw	Max. 100 mA at 24 V DC
Power dissipation	Max. 2.4 W
Ambient conditions	
- Ambient temperature	-40 °C ... +75 °C
- Transport and storage temperature	-40 to +85 °C
- Relative air humidity	95 % r H without condensation
- Pollution degree	2
- Protection rating	IP20
Certifications	CE, UL
UL	UL 61010-1/ UL 61010-2-201

- Voltage supply	DC 24 V (18 ... 30 V DC, SELV and limited energy circuit)
- Pollution degree	2
- Altitude	Up to 2,000 m
- Temperature cable rating	87 °C

### REX 100 Wi-Fi (700-875-WIF01) + (700-875-WIF51)

Dimensions (DxWxH)	37 x 58,5 x 76,5 mm
Weight	Approx. 130 g
Number of inputs   type	2   DC 24 V, as per DIN EN 61131-2 Type 2
Number of outputs   type	2   DIN EN 61131-2 Type 3
Wi-Fi interface	RP-SMA socket
- Type	IEEE802.11b/g&802.11n(1T1Rmode),to 150 Mbps
- Frequency range	EU (2.412 GHz - 2.472 GHz, 1-13 Channel) USA (2.412 GHz - 2.462 GHz, 1-11 Channel)
- Transmission speed	802.11b: 1, 2, 5.5, 11 Mbps 802.11g: 6, 9, 12, 18, 24, 36, 48, 54 Mbps 802.11n: (20 Mhz) MCS0-7, up to 72 Mbps 802.11n: (40 MHz) MCS0-7, up to 150 Mbps
- Wireless security methods	WPA/WP2, 64-/128-/152-bit WEP, WPS
Network interfaces	4x LAN (700-875-WIF01); 3x LAN + 1x WAN (700-875-WIF51)
- Type	10 Base-T/100 Base-T
- Connection	RJ45 socket
- Transmission rate	10/100 Mbps
USB interface	1 x
- Protocol	USB 2.0 host
- Connection	USB A socket
Status indicator	4 LEDs function status 8 LEDs Ethernet status
Voltage supply	DC 24 V, 18 ... 30 V DC
Current draw	Max. 120 mA at 24 V DC
Power dissipation	Max. 2.9 W
Ambient conditions	
- Ambient temperature	0 °C ... +60 °C
- Transport and storage temperature	-40 to +60 °C
- Relative air humidity	95 % r H without condensation

- Pollution degree	2
- Protection rating	IP20
Certifications	CE, UL
UL (only 700-875-WIF01)	UL 61010-1/ UL 61010-2-201
- Voltage supply	DC 24 V (18 ... 30 V DC, SELV and limited energy circuit)
- Pollution degree	2
- Altitude	Up to 2,000 m
- Temperature cable rating	87 °C

## Notes:

*The contents of this Quick Start Guide have been checked by us so as to ensure that they match the hardware and software described. However, we assume no liability for any existing differences, as these cannot be fully ruled out. The information in this Quick Start Guide is, however, updated on a regular basis.*

*When using your purchased products, please make sure to use the latest version of this Quick Start Guide, which can be viewed and downloaded on the Internet at [www.helmholz.com](http://www.helmholz.com).*

*Our products contain open source software, among others. This software is subject to the respectively relevant license conditions. We can send you the corresponding license conditions, including a copy of the complete license text together with the product. They are also provided in our download area of the respective products under [www.helmholz.de](http://www.helmholz.de). We also offer to send you or any third party the complete corresponding source text of the respective open source software for an at-cost fee of 10.00 Euro as a DVD upon request. This offer is valid for a period of three years, starting from the date of product delivery.*

*Our customers are important to us. We are pleased to receive suggestions for improvement and new impulses. Should you have any questions concerning the use of the product, please contact Helmholtz Support by telephone or write an e-mail an [support@helmholz.de](mailto:support@helmholz.de)*

- 1) Simatic and STEP 7 are registered trademarks of Siemens AG.*
- 2) Windows is a registered trademark of the Microsoft Corporation.*